

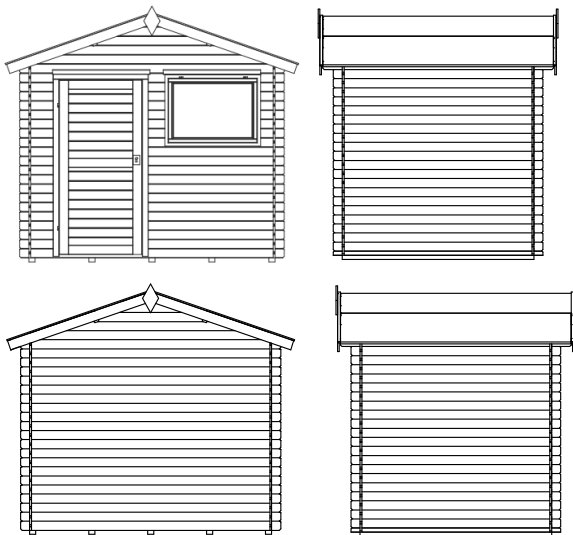

# SALLY 2418 18MM

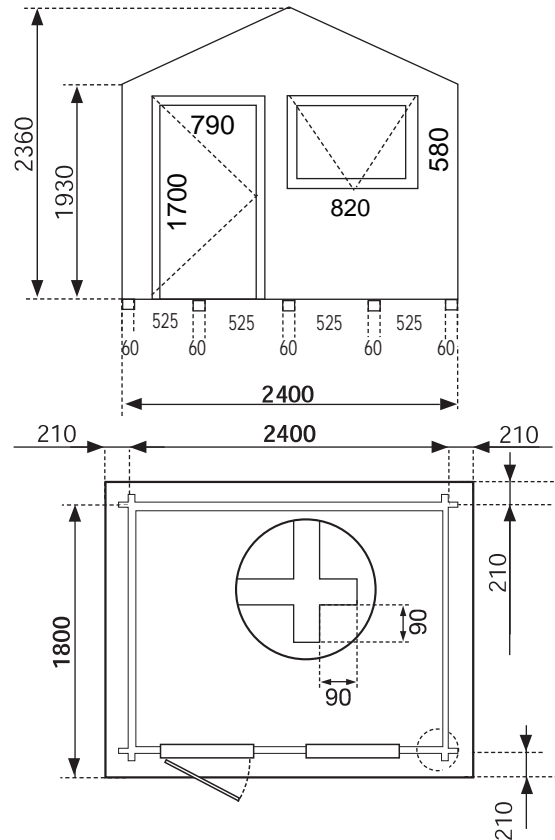

|   |   |   |   |   |  |   |   |   |         |        |                    |
|---|---|---|---|---|--|---|---|---|---------|--------|--------------------|
|  |  |  |  |  |  |  |  |  |         |        |                    |
|   |   |   |   |   |  |   |   |   | Art. N. | Ean.N. | 4,32m <sup>2</sup> |
| SALLY2418 18MM  | 59105102  | 5999553063943   |   |   |  |   | X   | Y   | Z       | kg     | 290                |

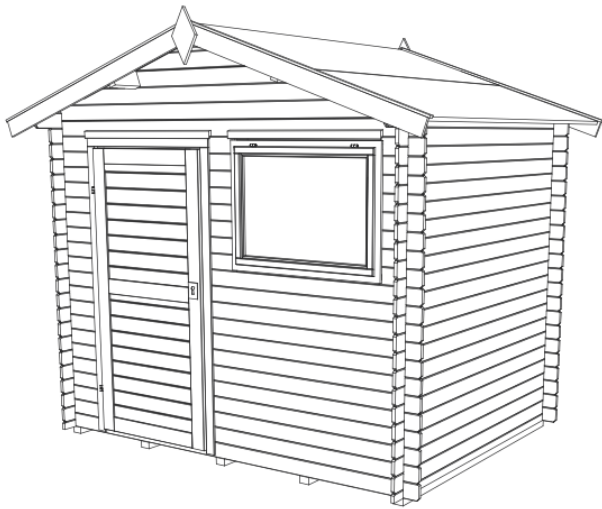
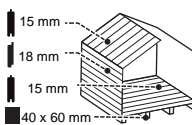
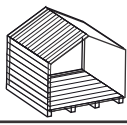
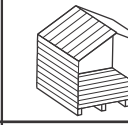
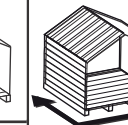
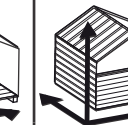
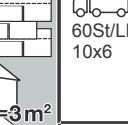
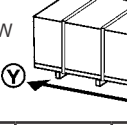
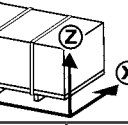